

Linoleum Panels



Linoleum Panels

Our acoustic panels with a linoleum surface allow you to create a unique and personal touch in your interior design. With 21 different color tones and 2 different slat widths, you can easily find a product that meets your specific needs. Linoleum is an exclusive and durable natural material that offers a modern and sophisticated look, and is a strong alternative to more traditional wood types.

In addition to the stylish design, the panels have the same excellent acoustic properties as our other products, meaning they effectively break and absorb sound waves, reducing noise levels by up to 50%. This creates a more pleasant and quiet environment, both at home and in the workplace. With their environmentally friendly Nordic Swan Ecolabel certification and the use of recycled materials in production, our linoleum panels are not only an aesthetic addition to your home but also a responsible choice that combines design and function.

With our Linoleum Panels, you get:

Creative Freedom

Linoleum Panels give you endless possibilities to create your own unique expression and design.

Exclusive Design

An exclusive look, produced with a focus on aesthetics and elegance.

Danish Craftsmanship

Produced in Central Jutland, ensuring high quality standards through Danish design and production.

The Responsible Choice

At the end of their life cycle, the panels can be recycled, emphasizing our commitment to responsible design and environmental awareness.

Features:

- **Local production**
All panels are produced in Denmark.
- **Attractive square meter price**
Competitive price per square meter.
- **Quick assembly**
Easy and quick installation.
- **Minimal use of tools**
Requires only a few tools for installation and adjustment.
- **Lightweight construction**
The panels have a low weight, which simplifies handling.
- **Varied surface options**
Options for different veneer surfaces and core colors.
- **Durable natural material**
Linoleum is made from natural materials, with the main ingredient being linseed oil, extracted from flax seeds.
- **Environmentally certified materials**
Linoleum Panels are certified with the Nordic Swan Ecolabel.
- **Cleaning**
Our panels can easily be cleaned with a wrung-out damp cloth.



Nordic Swan Ecolabel certified.



Sorted as recycled wood.

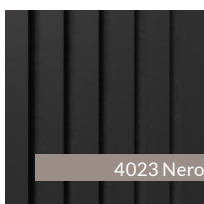

4023 Nero

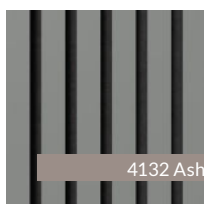

4132 Ash

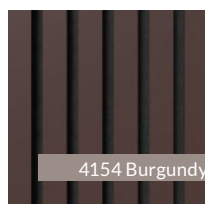

4154 Burgundy

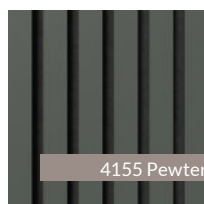

4155 Pewter

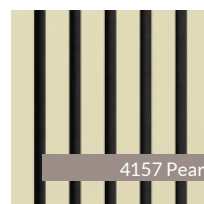

4157 Pearl

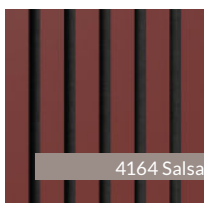

4164 Salsa

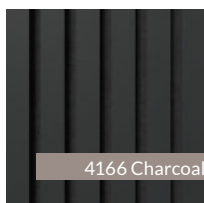

4166 Charcoal



4172 Mauve

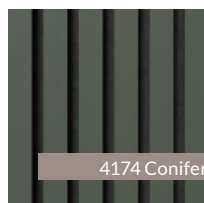

4174 Conifer



4175 Pebble

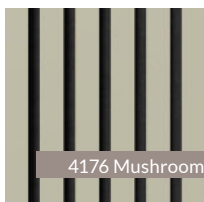

4176 Mushroom

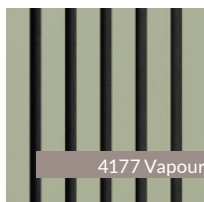

4177 Vapour

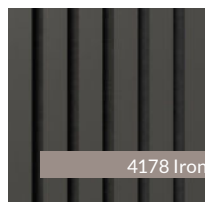

4178 Iron

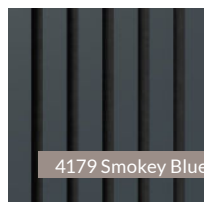

4179 Smokey Blue

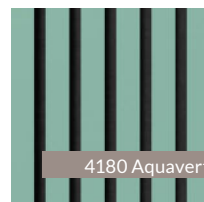

4180 Aquavert

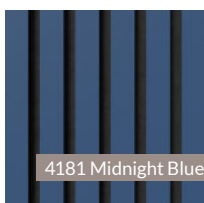

4181 Midnight Blue

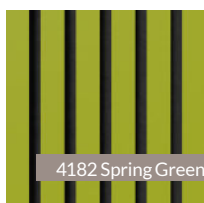

4182 Spring Green

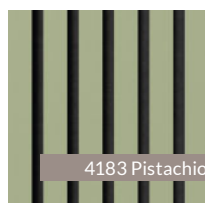

4183 Pistachio

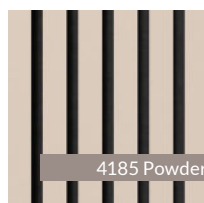



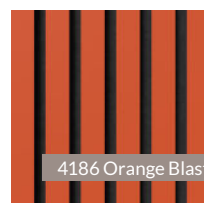





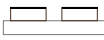































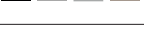





4185 Powder



4186 Orange Blast

Specifications 27 mm







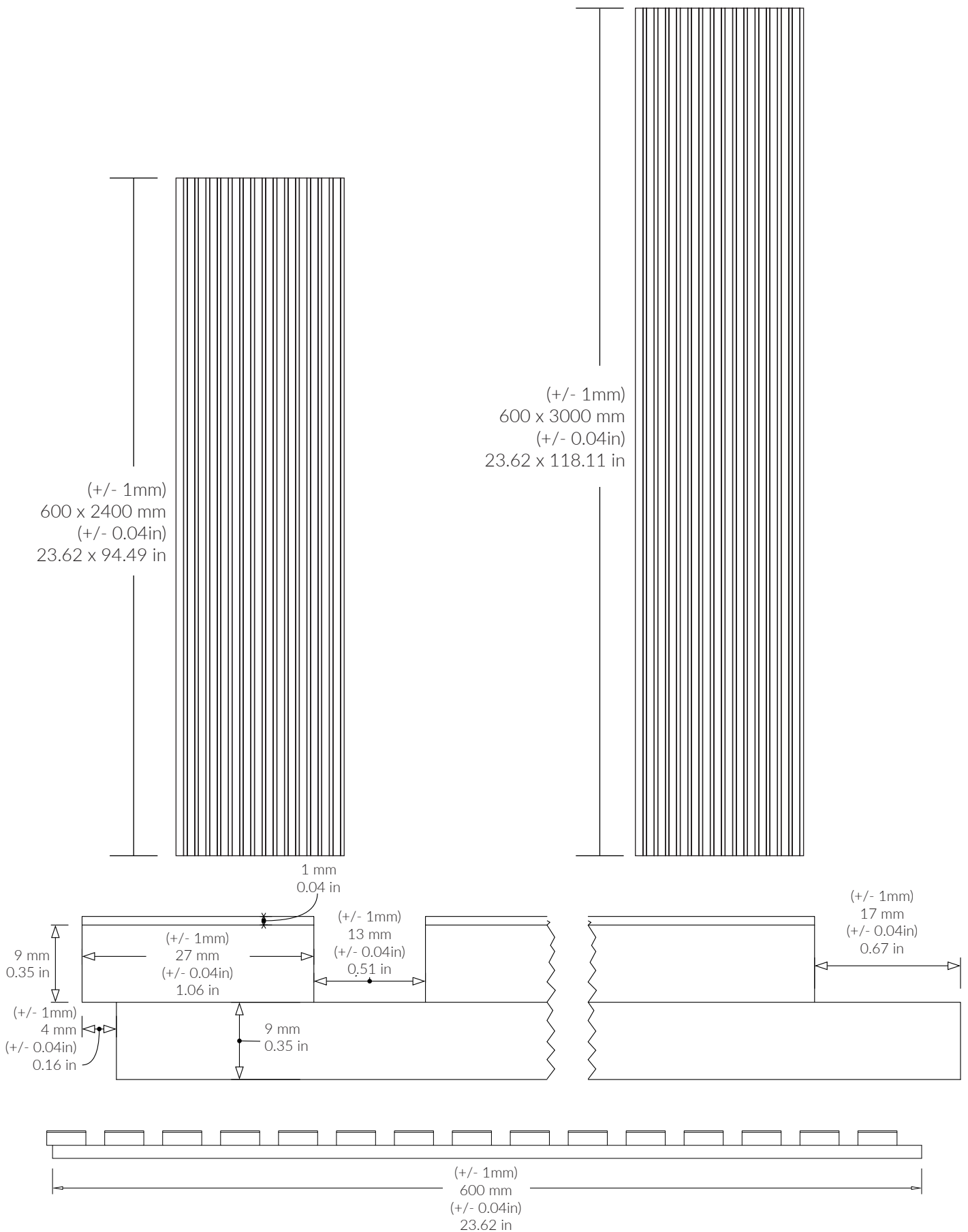



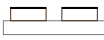





























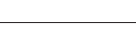





 Surface	 Core	 Felt	 Dimensions	 m ² - f ²	 Weight
4023 Nero			2400 x 600 x 20 mm - 94.49 x 23.62 x 0.79 in 3000 x 600 x 20 mm - 118.11 x 23.62 x 0.79 in	1,44 1,80	10,3 kg 12,9 kg
4132 Ash			2400 x 600 x 20 mm - 94.49 x 23.62 x 0.79 in 3000 x 600 x 20 mm - 118.11 x 23.62 x 0.79 in	1,44 1,80	10,3 kg 12,9 kg
4154 Burgundy			2400 x 600 x 20 mm - 94.49 x 23.62 x 0.79 in 3000 x 600 x 20 mm - 118.11 x 23.62 x 0.79 in	1,44 1,80	10,3 kg 12,9 kg
4155 Pewter			2400 x 600 x 20 mm - 94.49 x 23.62 x 0.79 in 3000 x 600 x 20 mm - 118.11 x 23.62 x 0.79 in	1,44 1,80	10,3 kg 12,9 kg
4157 Pearl			2400 x 600 x 20 mm - 94.49 x 23.62 x 0.79 in 3000 x 600 x 20 mm - 118.11 x 23.62 x 0.79 in	1,44 1,80	10,3 kg 12,9 kg
4164 Salsa			2400 x 600 x 20 mm - 94.49 x 23.62 x 0.79 in 3000 x 600 x 20 mm - 118.11 x 23.62 x 0.79 in	1,44 1,80	10,3 kg 12,9 kg
4166 Charcoal			2400 x 600 x 20 mm - 94.49 x 23.62 x 0.79 in 3000 x 600 x 20 mm - 118.11 x 23.62 x 0.79 in	1,44 1,80	10,3 kg 12,9 kg
4172 Mauve			2400 x 600 x 20 mm - 94.49 x 23.62 x 0.79 in 3000 x 600 x 20 mm - 118.11 x 23.62 x 0.79 in	1,44 1,80	10,3 kg 12,9 kg
4174 Conifer			2400 x 600 x 20 mm - 94.49 x 23.62 x 0.79 in 3000 x 600 x 20 mm - 118.11 x 23.62 x 0.79 in	1,44 1,80	10,3 kg 12,9 kg
4175 Pebble			2400 x 600 x 20 mm - 94.49 x 23.62 x 0.79 in 3000 x 600 x 20 mm - 118.11 x 23.62 x 0.79 in	1,44 1,80	10,3 kg 12,9 kg
4176 Mushroom			2400 x 600 x 20 mm - 94.49 x 23.62 x 0.79 in 3000 x 600 x 20 mm - 118.11 x 23.62 x 0.79 in	1,44 1,80	10,3 kg 12,9 kg
4177 Vapour			2400 x 600 x 20 mm - 94.49 x 23.62 x 0.79 in 3000 x 600 x 20 mm - 118.11 x 23.62 x 0.79 in	1,44 1,80	10,3 kg 12,9 kg
4178 Iron			2400 x 600 x 20 mm - 94.49 x 23.62 x 0.79 in 3000 x 600 x 20 mm - 118.11 x 23.62 x 0.79 in	1,44 1,80	10,3 kg 12,9 kg
4179 Smokey Blue			2400 x 600 x 20 mm - 94.49 x 23.62 x 0.79 in 3000 x 600 x 20 mm - 118.11 x 23.62 x 0.79 in	1,44 1,80	10,3 kg 12,9 kg
4180 Aquavert			2400 x 600 x 20 mm - 94.49 x 23.62 x 0.79 in 3000 x 600 x 20 mm - 118.11 x 23.62 x 0.79 in	1,44 1,80	10,3 kg 12,9 kg
4181 Midnight Blue			2400 x 600 x 20 mm - 94.49 x 23.62 x 0.79 in 3000 x 600 x 20 mm - 118.11 x 23.62 x 0.79 in	1,44 1,80	10,3 kg 12,9 kg
4182 Spring Green			2400 x 600 x 20 mm - 94.49 x 23.62 x 0.79 in 3000 x 600 x 20 mm - 118.11 x 23.62 x 0.79 in	1,44 1,80	10,3 kg 12,9 kg
4183 Pistachio			2400 x 600 x 20 mm - 94.49 x 23.62 x 0.79 in 3000 x 600 x 20 mm - 118.11 x 23.62 x 0.79 in	1,44 1,80	10,3 kg 12,9 kg
4184 Olive			2400 x 600 x 20 mm - 94.49 x 23.62 x 0.79 in 3000 x 600 x 20 mm - 118.11 x 23.62 x 0.79 in	1,44 1,80	10,3 kg 12,9 kg
4185 Powder			2400 x 600 x 20 mm - 94.49 x 23.62 x 0.79 in 3000 x 600 x 20 mm - 118.11 x 23.62 x 0.79 in	1,44 1,80	10,3 kg 12,9 kg
4186 Orange Blast			2400 x 600 x 20 mm - 94.49 x 23.62 x 0.79 in 3000 x 600 x 20 mm - 118.11 x 23.62 x 0.79 in	1,44 1,80	10,3 kg 12,9 kg

Tolerances

Tolerances: +/- 1mm (0.04 inches). Squareness: Length/width +/- 1mm (0.04 inches). Weight +/- 10%



Specifications 40 mm

 Surface	 Core	 Felt	 Dimensions	 m ² - f ²	 Weight
4023 Nero			2400 x 600 x 20 mm - 94.49 x 23.62 x 0.79 in 3000 x 600 x 20 mm - 118.11 x 23.62 x 0.79 in	1,44 1,80	11,4 kg 14,2 kg
4132 Ash			2400 x 600 x 20 mm - 94.49 x 23.62 x 0.79 in 3000 x 600 x 20 mm - 118.11 x 23.62 x 0.79 in	1,44 1,80	11,4 kg 14,2 kg
4154 Burgundy			2400 x 600 x 20 mm - 94.49 x 23.62 x 0.79 in 3000 x 600 x 20 mm - 118.11 x 23.62 x 0.79 in	1,44 1,80	11,4 kg 14,2 kg
4155 Pewter			2400 x 600 x 20 mm - 94.49 x 23.62 x 0.79 in 3000 x 600 x 20 mm - 118.11 x 23.62 x 0.79 in	1,44 1,80	11,4 kg 14,2 kg
4157 Pearl			2400 x 600 x 20 mm - 94.49 x 23.62 x 0.79 in 3000 x 600 x 20 mm - 118.11 x 23.62 x 0.79 in	1,44 1,80	11,4 kg 14,2 kg
4164 Salsa			2400 x 600 x 20 mm - 94.49 x 23.62 x 0.79 in 3000 x 600 x 20 mm - 118.11 x 23.62 x 0.79 in	1,44 1,80	11,4 kg 14,2 kg
4166 Charcoal			2400 x 600 x 20 mm - 94.49 x 23.62 x 0.79 in 3000 x 600 x 20 mm - 118.11 x 23.62 x 0.79 in	1,44 1,80	11,4 kg 14,2 kg
4172 Mauve			2400 x 600 x 20 mm - 94.49 x 23.62 x 0.79 in 3000 x 600 x 20 mm - 118.11 x 23.62 x 0.79 in	1,44 1,80	11,4 kg 14,2 kg
4174 Conifer			2400 x 600 x 20 mm - 94.49 x 23.62 x 0.79 in 3000 x 600 x 20 mm - 118.11 x 23.62 x 0.79 in	1,44 1,80	11,4 kg 14,2 kg
4175 Pebble			2400 x 600 x 20 mm - 94.49 x 23.62 x 0.79 in 3000 x 600 x 20 mm - 118.11 x 23.62 x 0.79 in	1,44 1,80	11,4 kg 14,2 kg
4176 Mushroom			2400 x 600 x 20 mm - 94.49 x 23.62 x 0.79 in 3000 x 600 x 20 mm - 118.11 x 23.62 x 0.79 in	1,44 1,80	11,4 kg 14,2 kg
4177 Vapour			2400 x 600 x 20 mm - 94.49 x 23.62 x 0.79 in 3000 x 600 x 20 mm - 118.11 x 23.62 x 0.79 in	1,44 1,80	11,4 kg 14,2 kg
4178 Iron			2400 x 600 x 20 mm - 94.49 x 23.62 x 0.79 in 3000 x 600 x 20 mm - 118.11 x 23.62 x 0.79 in	1,44 1,80	11,4 kg 14,2 kg
4179 Smokey Blue			2400 x 600 x 20 mm - 94.49 x 23.62 x 0.79 in 3000 x 600 x 20 mm - 118.11 x 23.62 x 0.79 in	1,44 1,80	11,4 kg 14,2 kg
4180 Aquavert			2400 x 600 x 20 mm - 94.49 x 23.62 x 0.79 in 3000 x 600 x 20 mm - 118.11 x 23.62 x 0.79 in	1,44 1,80	11,4 kg 14,2 kg
4181 Midnight Blue			2400 x 600 x 20 mm - 94.49 x 23.62 x 0.79 in 3000 x 600 x 20 mm - 118.11 x 23.62 x 0.79 in	1,44 1,80	11,4 kg 14,2 kg
4182 Spring Green			2400 x 600 x 20 mm - 94.49 x 23.62 x 0.79 in 3000 x 600 x 20 mm - 118.11 x 23.62 x 0.79 in	1,44 1,80	11,4 kg 14,2 kg
4183 Pistachio			2400 x 600 x 20 mm - 94.49 x 23.62 x 0.79 in 3000 x 600 x 20 mm - 118.11 x 23.62 x 0.79 in	1,44 1,80	11,4 kg 14,2 kg
4184 Olive			2400 x 600 x 20 mm - 94.49 x 23.62 x 0.79 in 3000 x 600 x 20 mm - 118.11 x 23.62 x 0.79 in	1,44 1,80	11,4 kg 14,2 kg
4185 Powder			2400 x 600 x 20 mm - 94.49 x 23.62 x 0.79 in 3000 x 600 x 20 mm - 118.11 x 23.62 x 0.79 in	1,44 1,80	11,4 kg 14,2 kg
4186 Orange Blast			2400 x 600 x 20 mm - 94.49 x 23.62 x 0.79 in 3000 x 600 x 20 mm - 118.11 x 23.62 x 0.79 in	1,44 1,80	11,4 kg 14,2 kg

Tolerances

Tolerances: +/- 1mm (0.04 inches). Squareness: Length/width +/- 1mm (0.04 inches). Weight +/- 10%

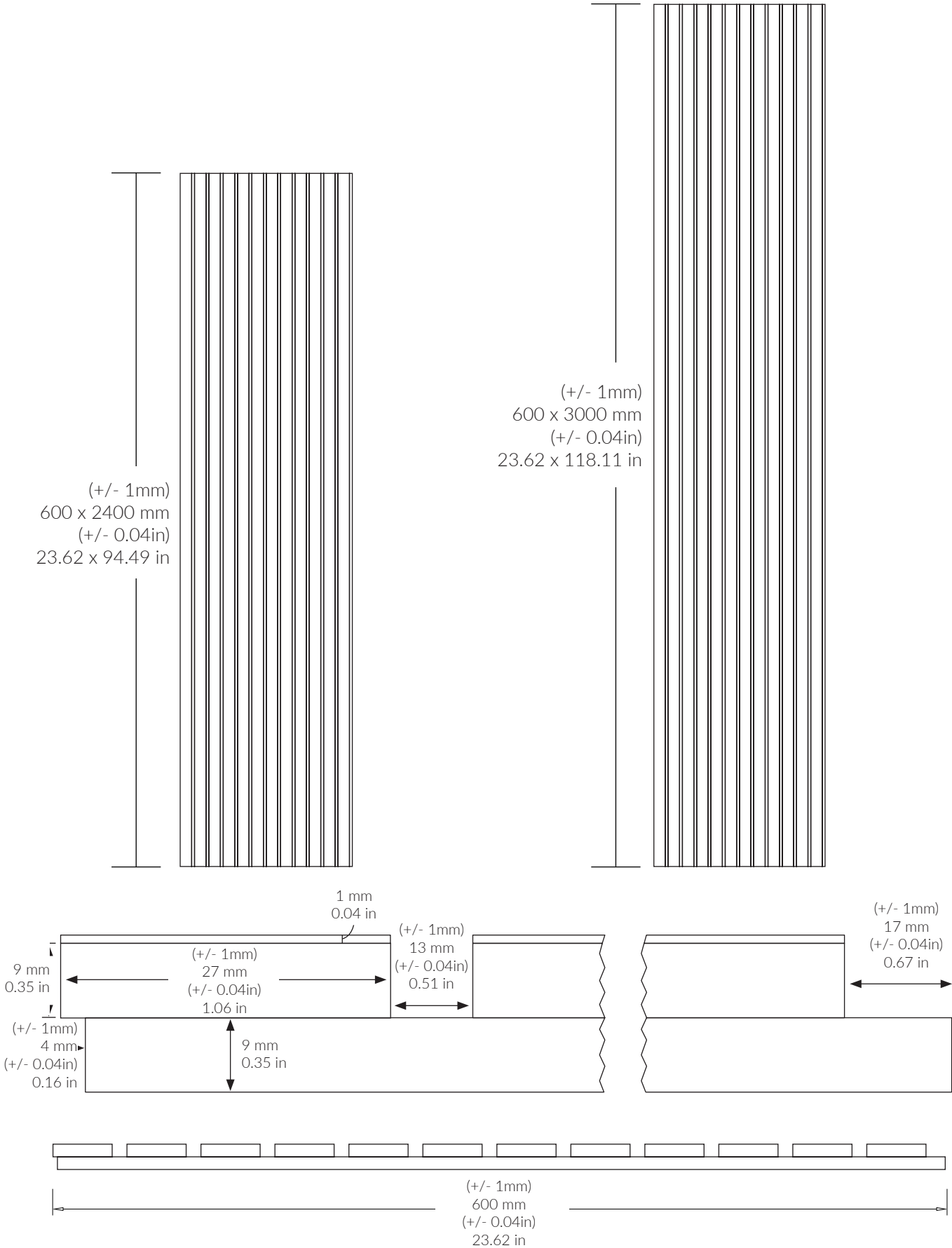

Acoustic Measurements

Sound test according to DS/EN ISO 354:2003

Sound test with 45mm air behind the panel

Test area: 10,8 m²
 Room volume: 215 m³
 Room surface area: 305 m²

Frequency [Hz]	α_s
100	0.09
125	0.22
160	0.30
200	0.53
250	0.56
315	0.87
400	0.99
500	0.97
630	0.97
800	1.02
1k	1.02
1.25k	0.91
1.6k	0.90
2k	0.87
2.5k	0.80
3.15k	0.81
4k	0.77
5k	0.71

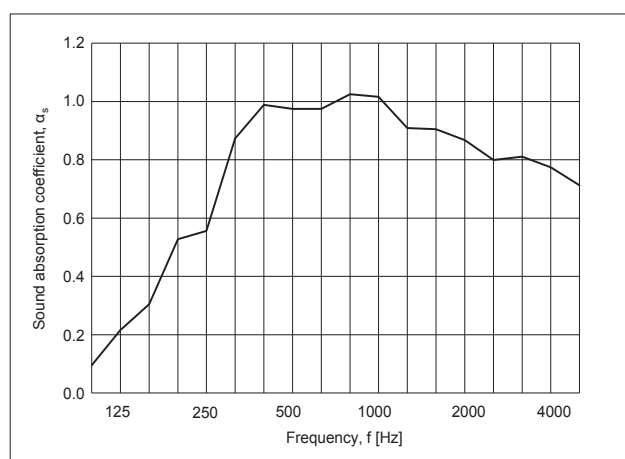

Figure 1: Sound test mounted with 45 mm air behind the panel. Closed frame around the edge.

Sound test with direct wall mounting

Test area: 10,8 m²
 Room volume: 215 m³
 Room surface area: 305 m²

Frequency [Hz]	α_s
100	0.02
125	0.02
160	0.02
200	0.05
250	0.05
315	0.11
400	0.16
500	0.26
630	0.32
800	0.46
1k	0.63
1.25k	0.78
1.6k	0.97
2k	1.11
2.5k	1.05
3.15k	0.88
4k	0.75
5k	0.68

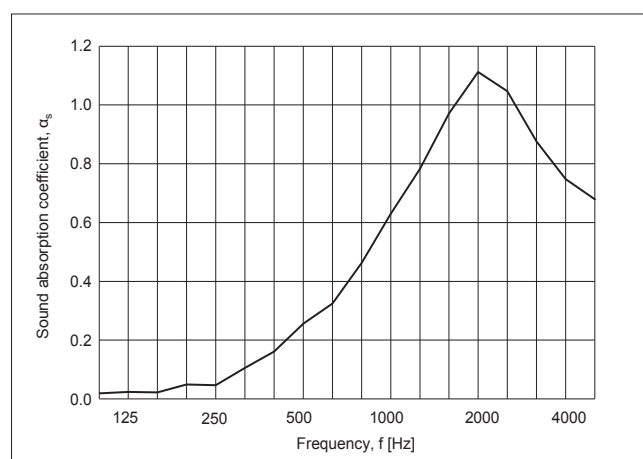
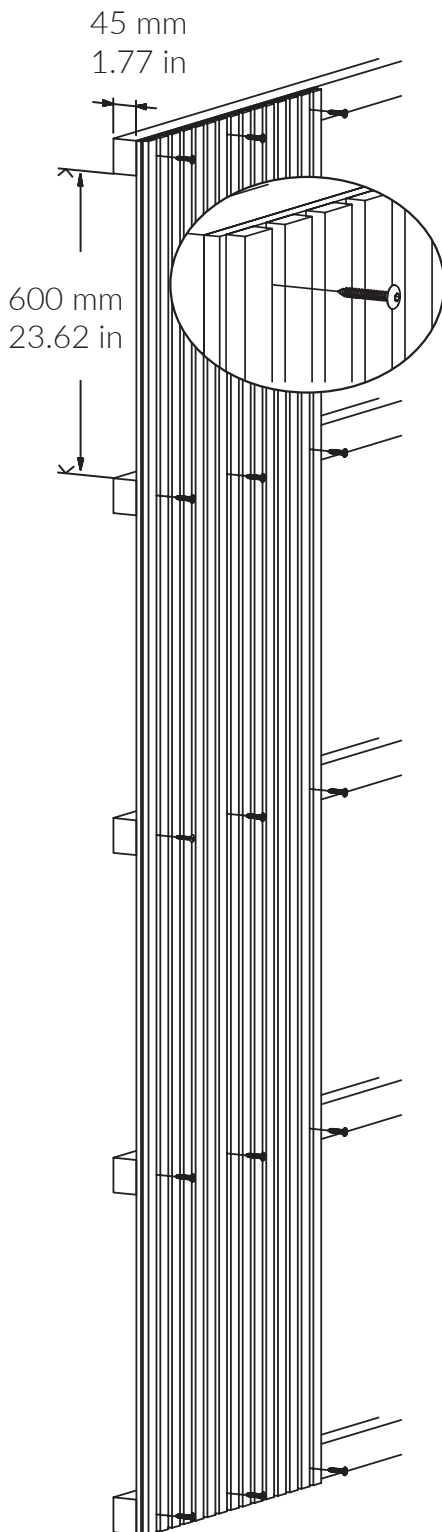

Figure 2: The sound test shows direct wall mounting.

Tests:

Formaldehyde test: Danish Technological Institute
 Indoor climate test: Danish Technological Institute
 Acoustic test: Danish Technological Institute

Installation Guide



Method 1

- Directly on the wall

Mounting adhesive: Apply the adhesive to the panel and place it against the wall. Ensure it is firmly pressed.

Screws: Screw the panel through the felt and into the wall. We recommend using 4 screws per panel. Remember to use wall plugs if your wall type requires it.

Method 2

- On a batten

For optimal sound absorption, set up a batten with 45 mm (1.77 in) battens on your wall. We recommend a spacing of 600 mm (23.62 in) between your battens. Insert mineral wool between the battens. Screw the panel onto the battens through the felt.

Panel adaptation:

If you need to customize the panels in width or length, we recommend using a plunge saw or circular saw for cutting.

Alternative mounting:

Nail gun diving





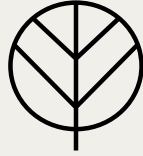

FOG & VENØ

Fog & Venø is a leading Danish manufacturer of acoustic and decorative panels with and without acoustic properties. These products are designed and manufactured with a focus on Danish craftsmanship and a constant pursuit of high quality.

The panels are suitable for installation on both walls and ceilings.

Fog & Venø has a strategic partnership with world-leading suppliers of materials such as wood veneer, linoleum, foil, and laminate, ensuring that all Fog & Venø products maintain a high standard and a wide range of options. This means that there is constantly reverberation in the room, and this is where our acoustic panels make a big difference.

Our Danish-produced acoustic panels break the sound and absorb the sound wave, so it dies out when it hits the panels. This means that the sound wave is eliminated and the reverberation time is shortened, which will improve the indoor climate and the feeling of well-being in the room, whether it is private, commercial, or public buildings we are talking about.

Kontaktinformation

Fog & Venø A/S
Buntmagervej 5, DK-7490 Aulum
Tel: (+45) 88 77 83 70
hello@fog-veno.com
www.fog-veno.com